



Product Catalog

Ürün Katalođu

 **exinplast**

Who we are ?

Exinplast is a new extrusion and injection plastic manufacturing company. We aim to grow rapidly with our experienced staff. By focusing on customer satisfaction, we strengthen our respected position in the sector with investment and innovation every year. We work meticulously to offer quality products in our 4000 square meter modern production area.

Biz Kimiz ?

Exinplast, yeni bir ekstrüzyon ve enjeksiyon plastik üretim firmasıdır. Deneyimli kadromuzla hızla büyümeyi hedefliyoruz. Müşteri memnuniyetine odaklanarak, her sene yatırım ve inovasyonla sektördeki saygın konumumuzu güçlendiriyoruz. 4000 metrekarelik modern üretim alanımızda, kaliteli ürünler sunmak için titizlikle çalışıyoruz.



İçindekiler / Contents

Endüstriyel Mutfak / Industrial Kitchen	5-6
Endüstriyel Soğutma / Industrial Refrigeration	7-9
Ekstrüzyon Profilleri / Extrusion Profiles	8-13
Enjeksiyon Parçaları / Injection Parts	14-17
Su Drenaj Sistemleri / Drainage Systems	18-19
Bağlantı Elemanları & Vidalı Sistemler / Fasteners and Screws Systems	20-21
Metal Bileşenli Plastikler / Metal Inserted Plastics	22-23
Tampon Profilleri / Bumper Profiles	24-26

Geyve / Sakarya



İletişim / Contact Us

Çeltikler, Soğanlık Sk. No:59, 54700 Geyve/Sakarya
+90 264 502 74 70
info@exinplast.com
www.exinplast.com



Exinplast ekstrüzyon ve enjeksiyon konusunda yaklaşık 20 yıla dayanan tecrübesiyle kurulmuş olduğu yıldan itibaren sektöre çok hızlı adapte olmuştur. Genç ve dinamik kadrosuyla sektörün ihtiyaçlarına kreatif çözümler bularak sektörde yerini almıştır. Sahip olduğu son teknoloji ürünü makine parkuru , kadrosunda uzmanlaşmış personeli ile hizmetlerini sürdürmektedir.

Çalıştığımız hammaddeler;

- * PVC (Soft & Hard)
- * TPE
- * POM
- * PP
- * ABS
- * PC
- * PMMA
- * Polyamid 6,6 & 6

Exinplast, with its nearly 20 years of experience in extrusion and injection, has adapted to the sector very quickly since the year it was founded. It has taken its place in the sector by finding creative solutions to the needs of the sector with its young and dynamic staff. It continues its services with its state-of-the-art machinery and expert staff.

The raw materials we work with;

- * PVC (Soft & Hard)
- * TPE
- *POM
- *PP
- *ABS
- * PC
- * PMMA
- * Polyamide 6,6 & 6



Industrial Kitchen

Endüstriyel Mutfak

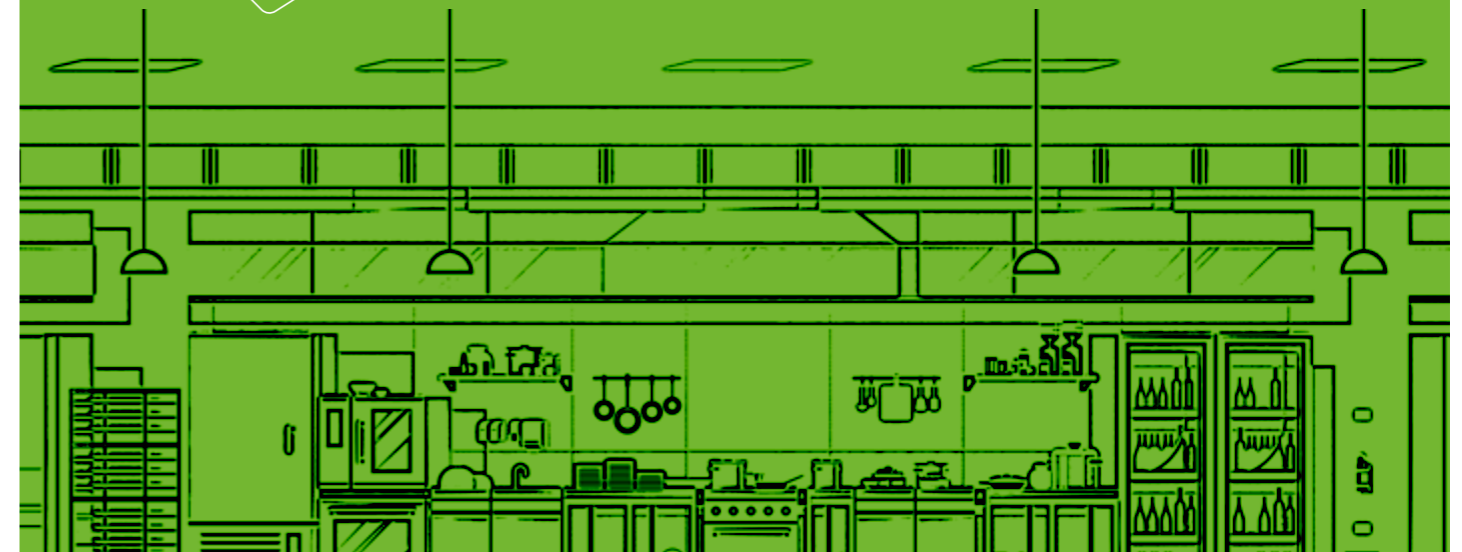

60' Case and Cover Profile
60'luk Kasa Kapak Profili

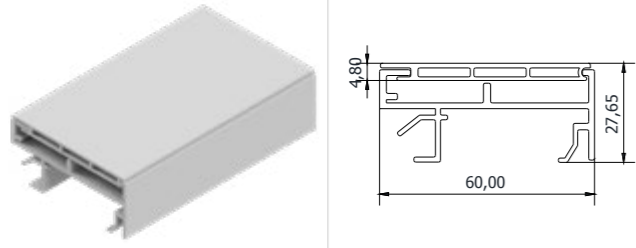

MME00091

50' Case and Cover Profile
50'luk Kasa Kapak Profili

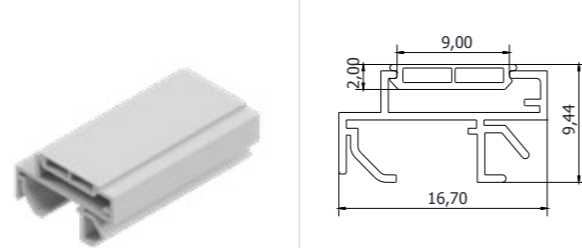

MME00095

Gasket Holder Profile
Conta Tutucu Profil

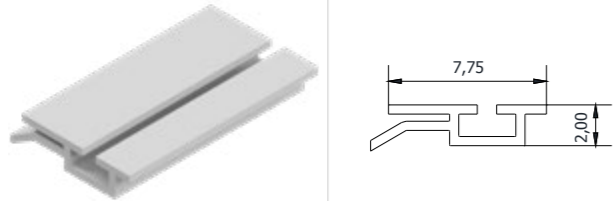

MME00092

Industrial Kitchen Cabinet Body Profile
Endüstriyel Mutfak Dolabı Gövde Profili

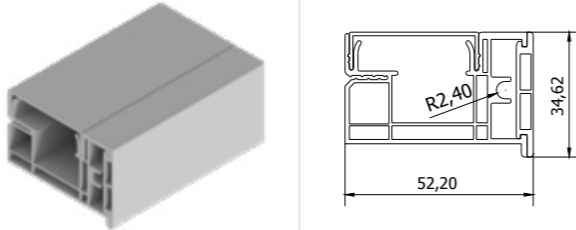

MME00081

Gasket Holder Profile 2
Conta Tutucu Profil 2

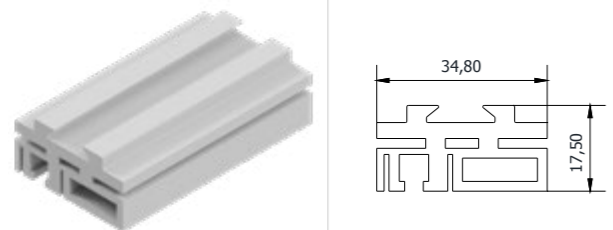

MME00131

Industrial Kitchen Cabinet Door Profile
Endüstriyel Mutfak Dolabı Kapı Profili

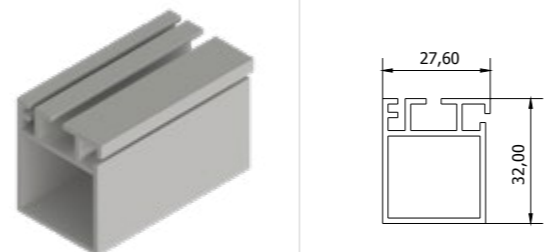

MME00150

Scanbox Profile
Scanbox Profile

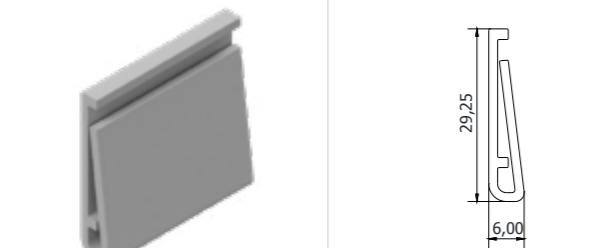

MME00151

Industrial Refrigeration
Endüstriyel Soğutma

Extrusion Profiles

Ekstrüzyon Profilleri

Body Frontal Profile
Gövde Alın Profili

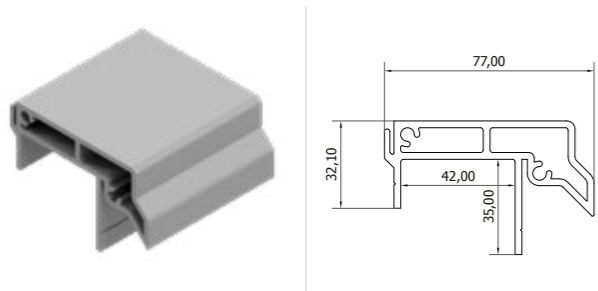

MME00049

Flat Kick Plate Profile
Düz Süpügelik Profili

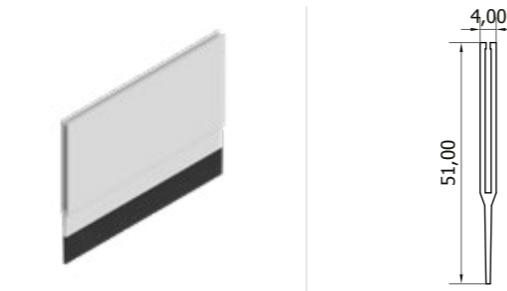

MME00089

Radiused Kick Plate Profile
Radüslü Süpügelik Profili

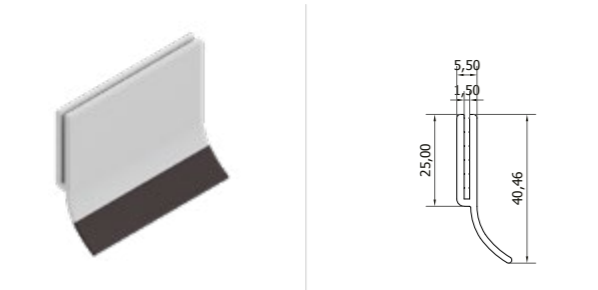

MME00102

Deepfreeze Triple Glass Bottom Profile
Derin Dondurucu Isıcam Alt Profili

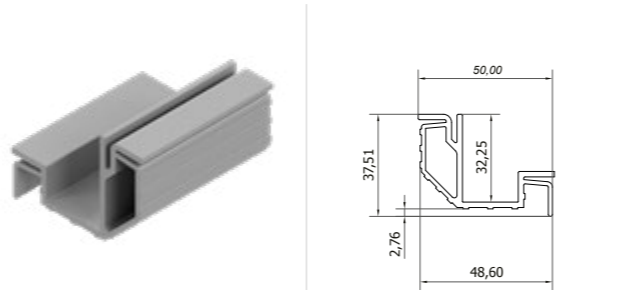

MME00080

Deepfreeze Triple Glass Pillar Profile
Derin Dondurucu Isıcam Dikme Profili

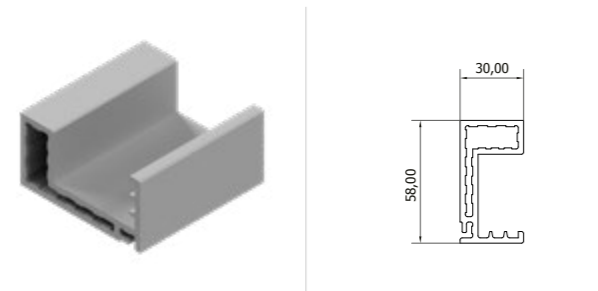

MME00074

Deepfreeze Triple Glass Cover Profile
Derin Dondurucu Isıcam Kapama Profili

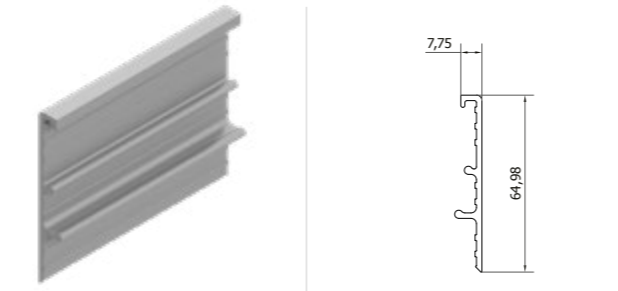

MME00067

Sliding Rail Profile
Sürgü Ray Profili

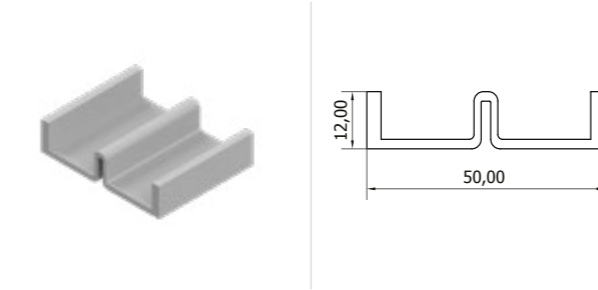

MME00099

Sliding Rail Profile for Wheels
Tekerli Sürgü Ray Profili

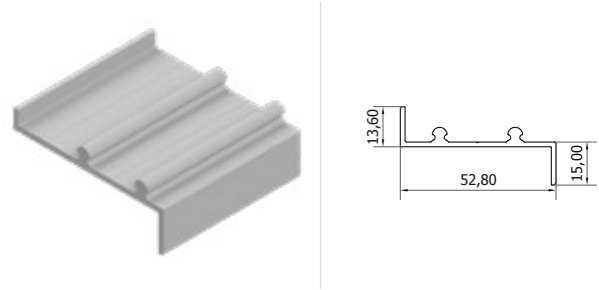

MME00001

Heat Barrier
Isı Bariyeri

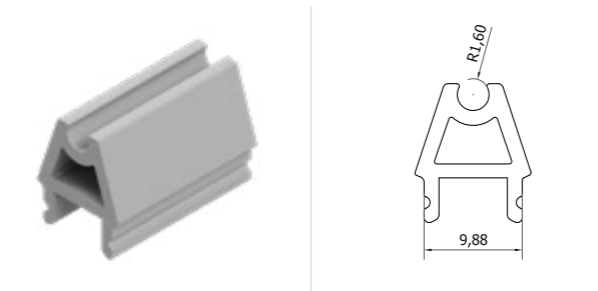

MME00034

Groined Frame Case Profile
Çerçeve Pervazlı Kasa Profili

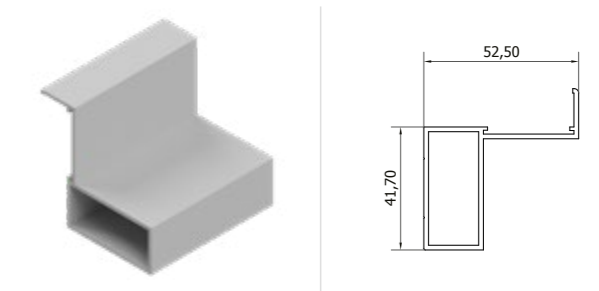

MME00019

Sheet Metal Holder Clip Profile
Sac Tutucu Kılıp Profili

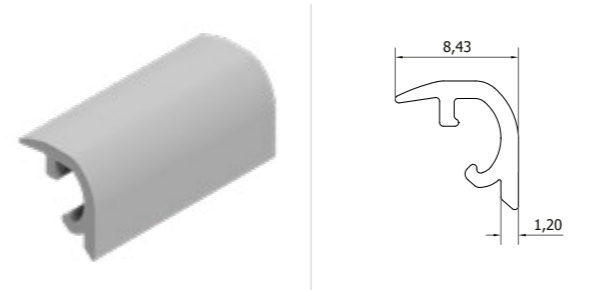

MME10036

Glass Door Wing Profile
Cam Kapı Kanat Profili

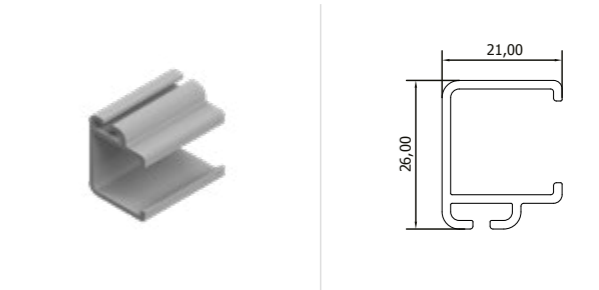

MME00023

Glass Door Profile
Cam Kapı Profili

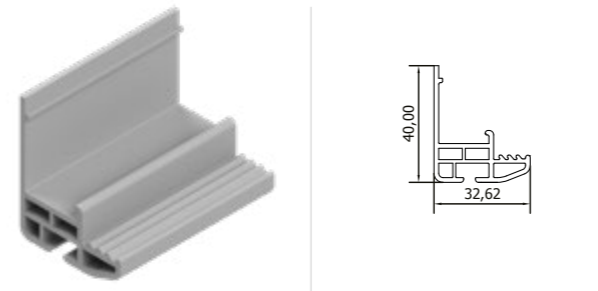

MME00100

Frame Case Middle Pillar Profile
Çerçeve Kasa Orta Kayıt Profili

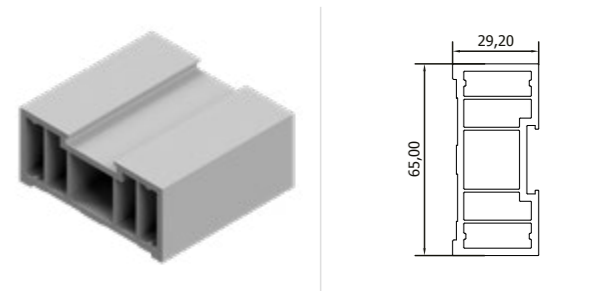

MME00139

Frame Case Profile
Çerçeve Kasa Profili

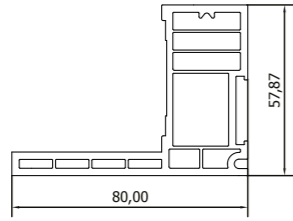

MME00140

Groined Frame Case Profile
Çerçeve Pervazlı Kasa Profili

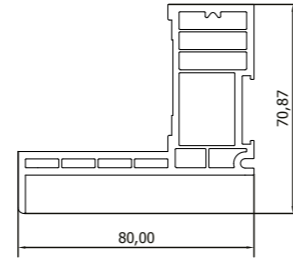

MME00141

Door Wing Profile with Handle
Kulplu Kapı Kanat Profili

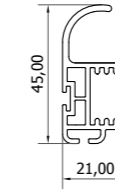

MME00029

Sliding Frame Bottom Support Profile
Sürgü Çerçeve Alt Destek Profili

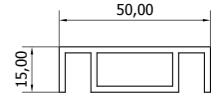
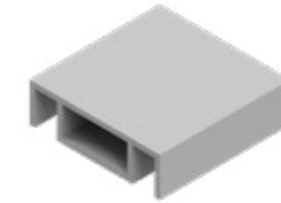

MME00145

Sliding Door Bottom Profile
Sürgü Kapı Alt Profili

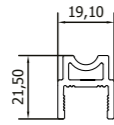

MME00142

Sliding Door Handle Profile
Sürgü Kapı Kulp Profili

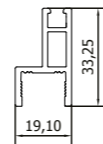

MME00143

Sliding Frame Pillar Case Profile
Sürgü Çerçeve Dikme Kasa Profili

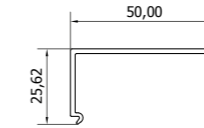
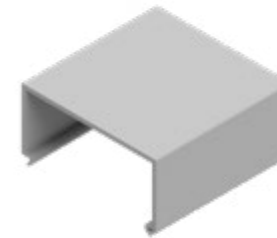

MME00146

Sliding Frame Pillar Cover Profile
Sürgü Çerçeve Dikme Kapak Profili

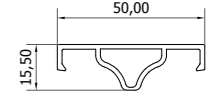

MME00147

Sliding Door Pillar Profile
Sürgü Kapı Dikme Profili

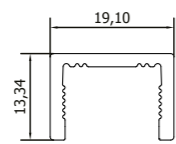
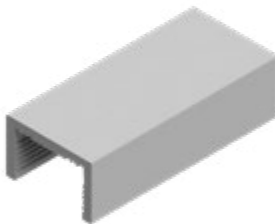

MME00144

Frame Case Rear Cover Profile
Çerçeve Kasa Arka Kapama Profili

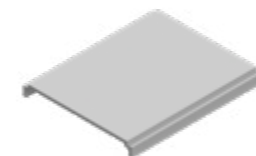

MME00138

Frame Side Pillar Profile
Çerçeve Yan Dikme Profili

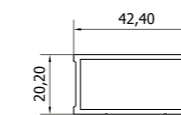
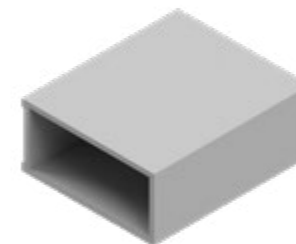

MME00011

Frame Middle Pillar Profile
Çerçeve Orta Dikme Profili

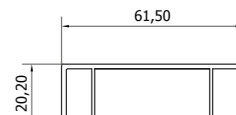
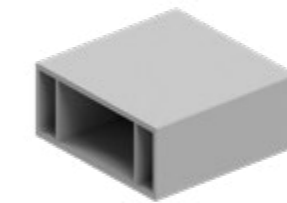

MME00003

Frame Bottom Case Profile with Hinge Slot
Çerçeve Menteşe Yuvalı Alt Kasa Profili

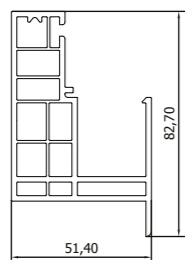

MME00111

Gronied Frame Case Profile and Gasket Slot
Çerçeve Pervazlı Kasa Profili ve Conta Yuvası

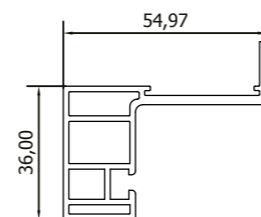

MME00109

Frame Case Middle Pillar Rear Cover Profile
Çerçeve Kasa Orta Kayıt Arka Kapama Profili

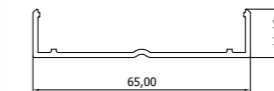
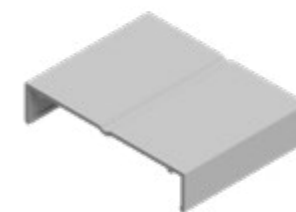

MMIO0035

Frame Case Side Pillar Rear Cover Profile
Çerçeve Kasa Yan Dikme Arka Kapama Profili

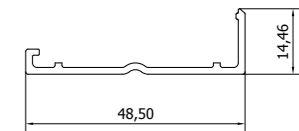
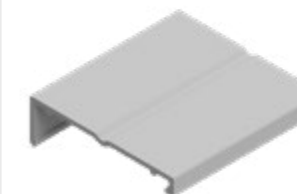

MMIO0035

Deepfreeze Triple Glass Decoration Profile
Derin Dondurucu Isıcam Dekor Profili

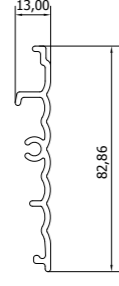

MME00064

Deepfreeze Corner Profile
Derin Dondurucu Köşe Profili

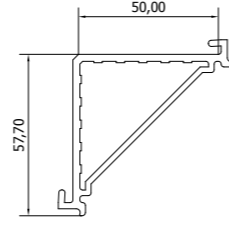
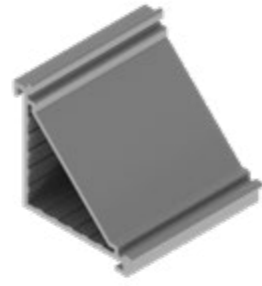

MME00072

Hand Rail Profile
El Rayı Profili

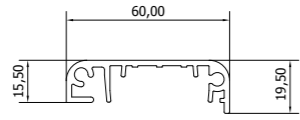

MME00068

Sliding Plexiglass Holder Profile
Sürgü Pleksi Tutucu Profili

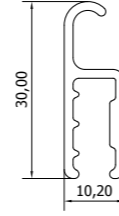

MME00077

14mm Glass Bead
14mm Cam Çıtası

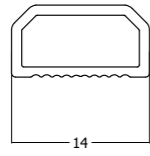

MME00215

Cedar Door Wing Profile
Cedar Kapı Kanat Profili

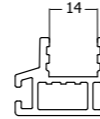

MME00191

Door Wing Profile with Handle 2
Kulplu Kapı Kanat Profeti 2

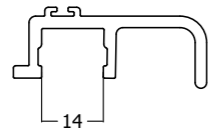

MME00068

L Profile
L Profil

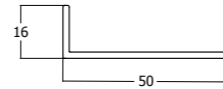

MME00206

Injection Parts

Enjeksiyon Parçaları



Hand Rail Corner Part
El Rayı Köşe Dönüş Plastiği

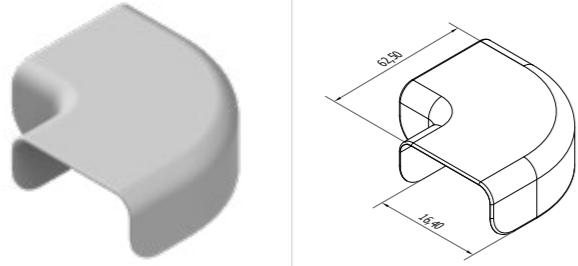

MMIO0018

Deep Freezer Blowing Holder Part
Derin Dondurucu Üfleme Yönlendirici Plastiği

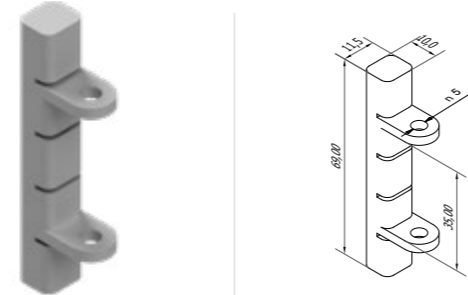

MMIO0016

Frame Joining Wedge
Çerçeve Birleştirme Takozu

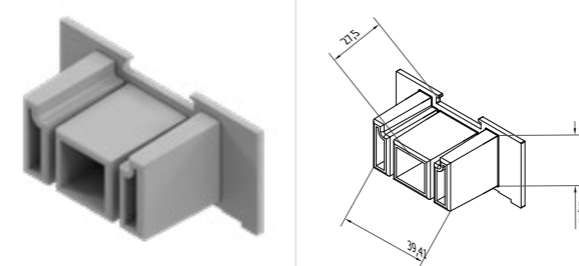

MMIO0002

Semi Vertical Door Bottom Profile Cover Plastic
Yarı Dikey Kapı Alt Profil Kapama Plastiği

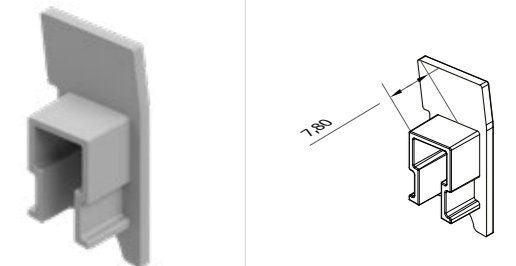

MMIO0003

Single Glass Holder Plastic
Tek Cam Tutucu Plastiği



MMIO0010

Solid Shelf Fixing Part
Sac Raf Sabitleme Plastiği

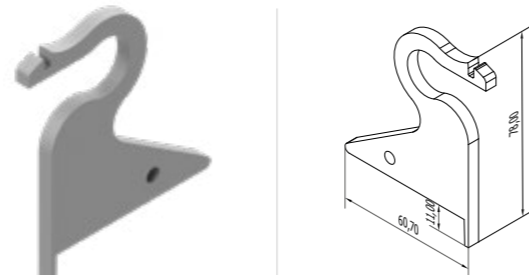

MMIO0035

Semi Vertical Door TopProfile Cover Plastic
Yarı Dikey Kapı Üst Profil Kapama Plastiği

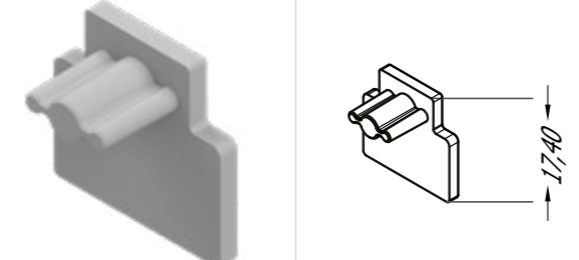

MMIO0005

Frame Pin Socket
Çerçeve Pim Soketi

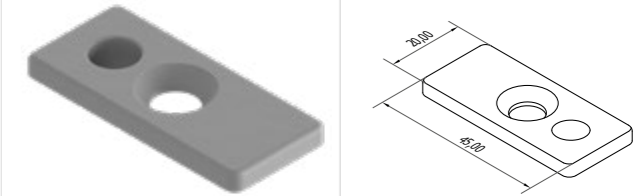

MMIO0015

Sliding Frame Pillar Case Profile
Menteşe Alt Destek Plastiği

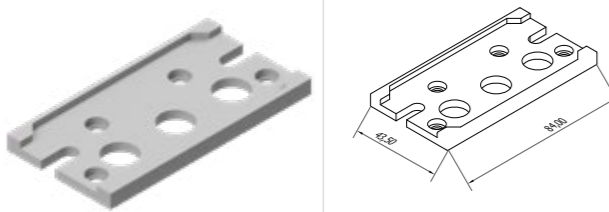

MMIO0022

Spring Holder Plastic
Yay Tutucu Plastik

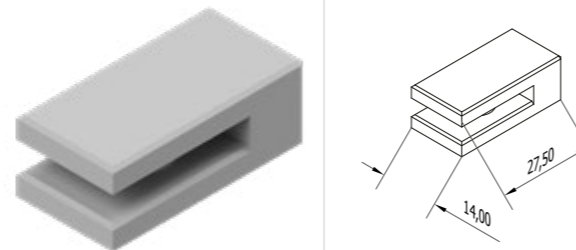

MMIO0081

Wing Profile Cover Plastic
Kapı Profil Kapama Plastiği

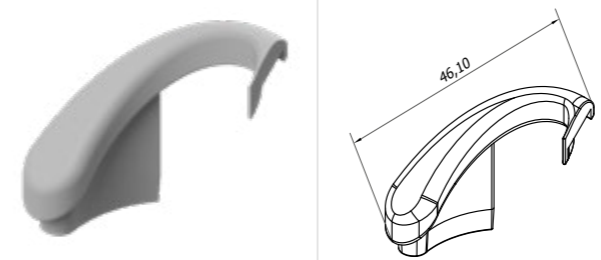

MMIO0020

Glass Door Electrical Outlet Plastic
Cam Kapı Elektrik Çıkış Plastiği

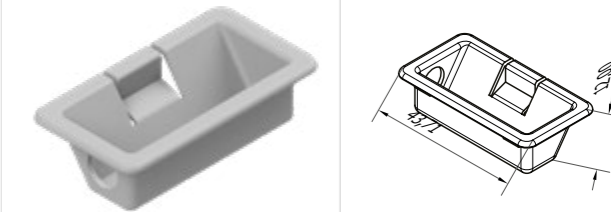

MMIO0028

Door Locking Plastic
Kapı Kilitleme Plastiği

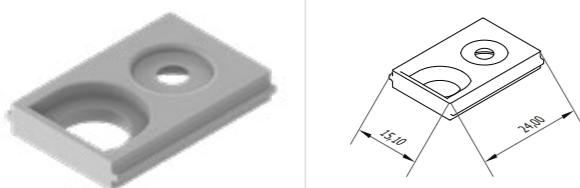

MMIO0015

Cable Outlet Plastic
Kablo Çıkış Plastiği

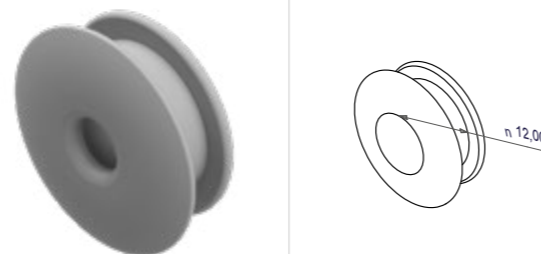

MML00165

Frame Electrical Outlet Plastic
Çerçeve Elektrik Çıkış Plastiği

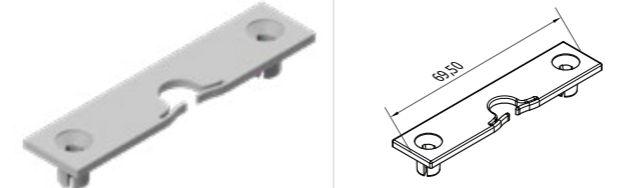

MMIO0029

Glass Door Hinge Bushing
Cam Kapı Menteşe Burcu

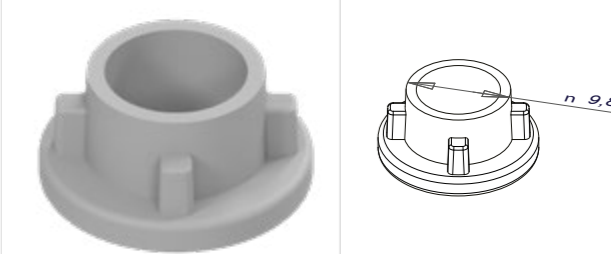

MMIO0030

Fan Circle Protection Cover Plastic
Fan Çember Koruma Kapağ Plastiği

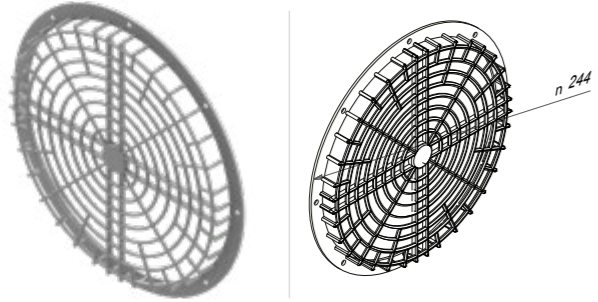

MMIO0037

Fan Circle Plastic
Fan Çember Plastiği

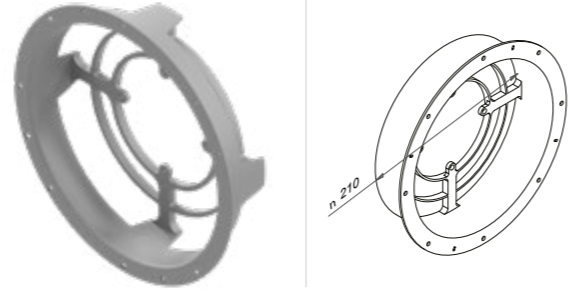

MMIO0039

Pin Lock Plastic
Pim Kilit Plastiği

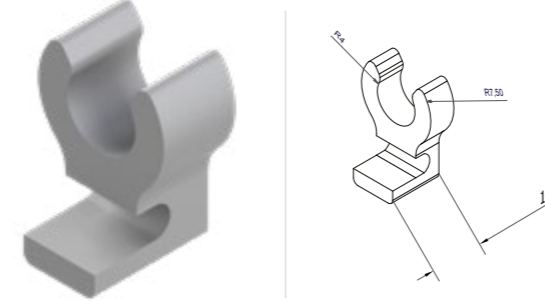

MMIO0074

R12 mm Hole Plug
R12 mm Delik Tapası

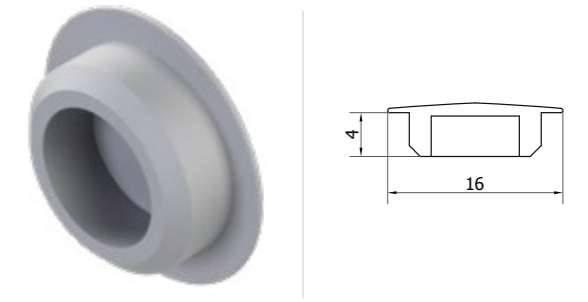

MMIO0064

Door Lock Plastic
Kapı Kilit Plastiği

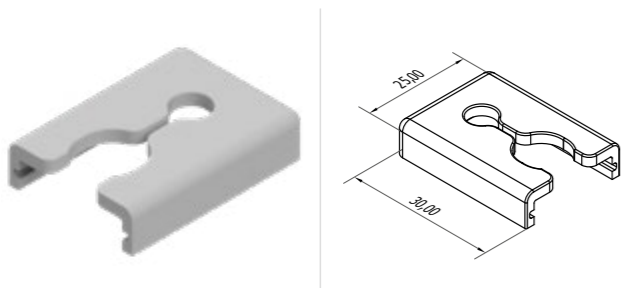

MMIO0082

Door End Cover Plastic
Kapı Bitim Kapama Plastiği

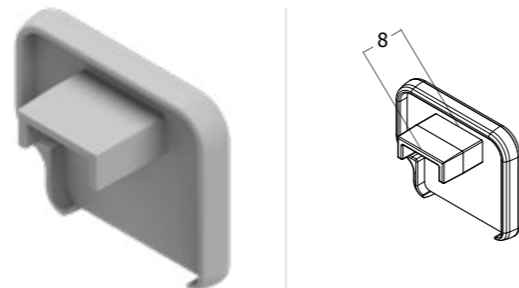

MMIO0013

Magnetic Gasket Finishing Plastic
Manyetik Conta Bitim Plastiği

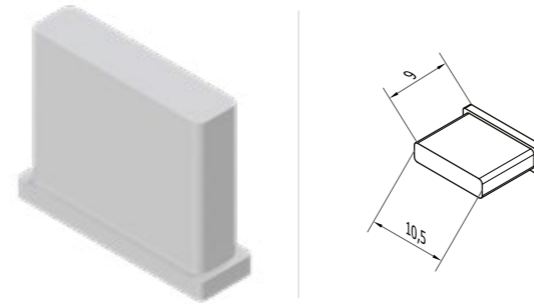

MMIO0063

Transparent Double Glazing Screw Bushing
Şeffaf Isıcam Vida Burcu



MMIO0058

Soft Pan Rubber
Yumuşak Tava Lastiği



MMIO0043

Cable Passing Plastic
Kablo Geçiş Plastiği



MMIO0083

Adhesive Sliding Handle
Bantlı Sürgü Kulpu



MMIO0096

Adhesive Hinged Door Handle
Bantlı Çarpma Kapı Kulbu

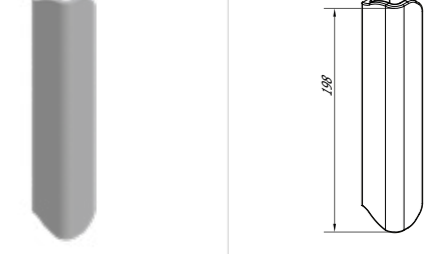

MMIO0071

Corner Torture Plastic
Köşe İşkence Plastiği

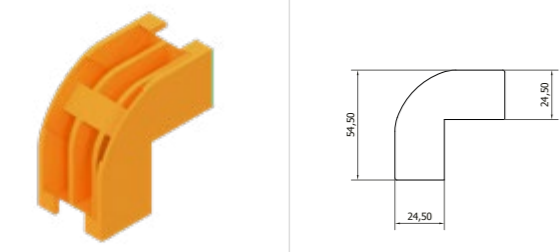

MMIO0084

Cabinet Sidewall Plug
Buzdolabı Yan Kapak Tapası

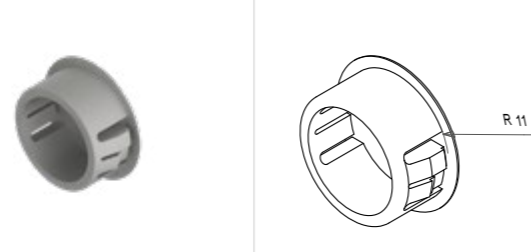

MMIO0040

Spacer Pin
Çita Pimi

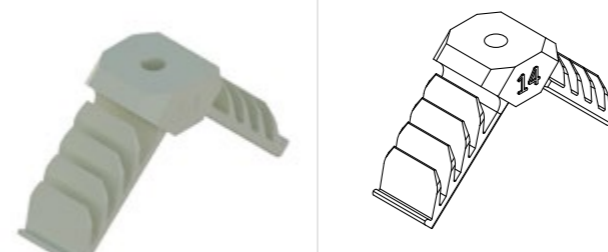

MMIO0125

Double Glass Argon Gas Plug
Isıcam Argan Gaz Tıkaç



MMIO0127

Drainage Systems

Drenaj Sistemleri

Water Drain Top Plastic
Su Gideri Üst Enjeksiyon Plastiği

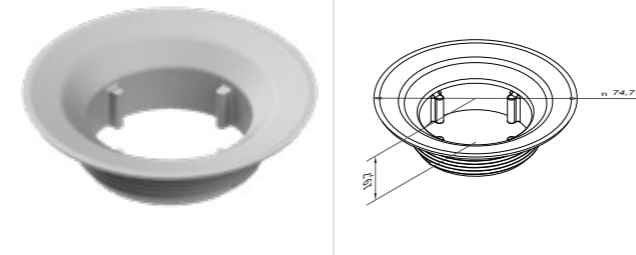

MMI00034

Water Drain Middle Plastic
Su Gideri Ara Enjeksiyon Plastiği

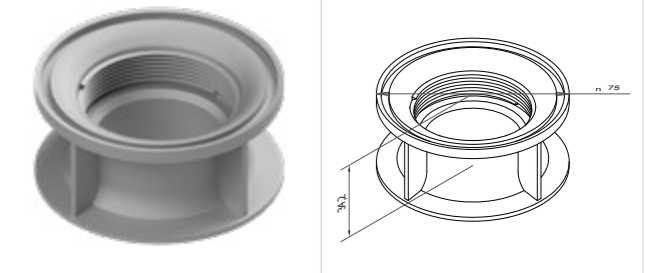

MMI00032

Water Drain Bottom Plastic
Su Gideri Alt Enjeksiyon Plastiği

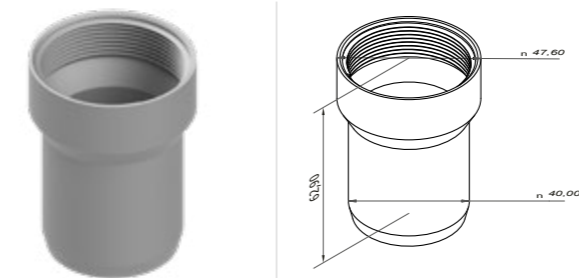

MMI00031

Water Drain "S" Shaped Syphon
Su Gider "S" Sifon

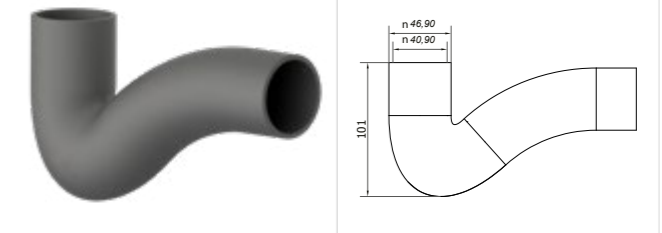

MMI00033

Water Drain Top Filter
Su Gideri Üst Süzgeç

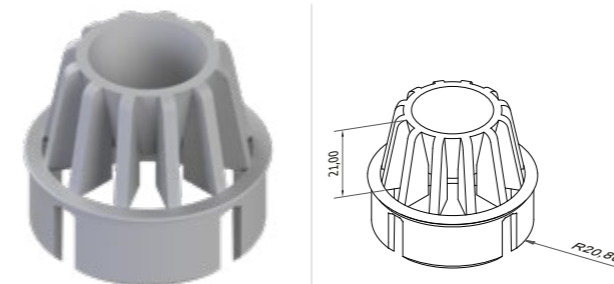

MMI00048

40mm Water Drain Pipe
40mm Su Gideri Borusu

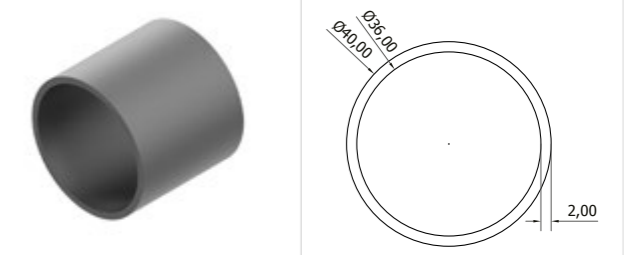

MME00098

40mm Water Drain T
40mm Su Gideri T

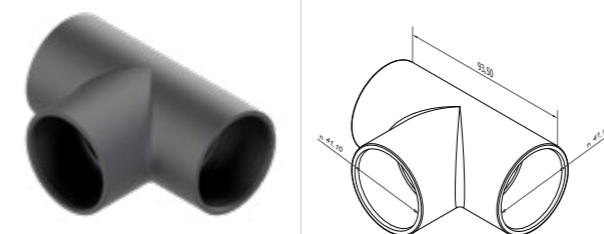

MMI00038

40mm Water Drain Elbow
40mm Su Gideri Dirseği

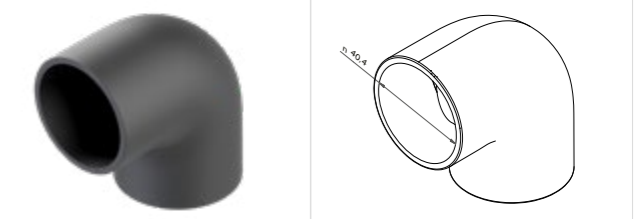

MMI00047

WATER DRAINAGE



EN

Each aisle used for display in the cooling sector produced a certain amount of water and this water was discharged from the cabinet with the help of a water drain. Unlike the water drains used in old-fashioned systems, the WDS product was completely redesigned considering the needs of the industry.

With the new design, water drain breaks during shipment are prevented and chronic problems are prevented. In addition, with its modular structure, parts can be replaced in case of damage.

Thanks to its gradual structure, it prevents 100% of possible water leaks. Hygiene and odor problems are not experienced together with the structure that enables water drainage to occur without any problems.

- Modular structure and repairability
- 0% leakage with staggered structure
- Easy assembly and installation
- Anti-break design

TR

Soğutma sektöründe teşhir için kullanılan her bir reyon, belli bir miktarda su üretir ve bu su dolaptan bir su gideri yardımı ile tahliye edilirdi. Eski usul sistemlerde kullanılan su giderlerin aksine, WDS ürünü tamamen sektörün ihtiyaçları göz önünde bulundurularak tekrardan tasarlandı.

Yeni tasarım ile birlikte sevkiyat sırasında yaşanan su gideri kırılmalarının önüne geçilmekte ve kronik problemlerin yaşanması engellenmektedir. Ayrıca modüler bir yapıda olması ile birlikte hasar yaşanan durumlarda parçalar değiştirilebilir.

Kademeli yapısı sayesinde olası su kaçağlarının %100 önüne geçmektedir. Su tahliyesinin sorunsuz bir şekilde gerçekleşmesini sağlayan yapı ile birlikte hijyen ve koku problemleri de yaşanmamaktadır.

- Modüler yapı ve onarılabilirlik
- Kademeli yapı ile %0 kaçak
- Kolay montaj ve kurulum
- Kırılmayı engelleyici tasarım

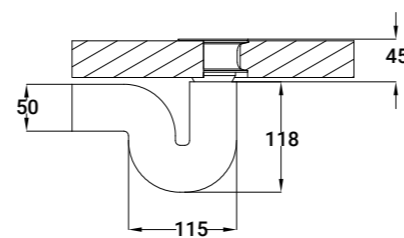
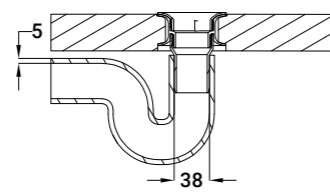
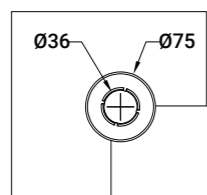
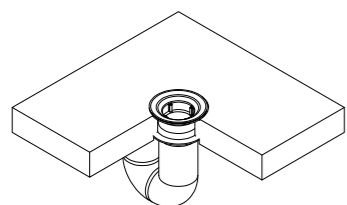

Fasteners and Screws Systems

Bağlantı Elemanları ve
Vidalı Sistemler

M16 Ball Joint Foot
M16 Rotil Ayak

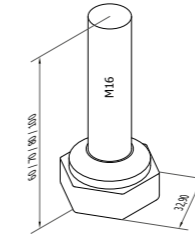

60mm - MMIO0023
70mm - MMIO0041
80mm - MMIO0067
100mm - MMIO0094

Piping Outlet Plastic
Boru Çıkış Plastiği

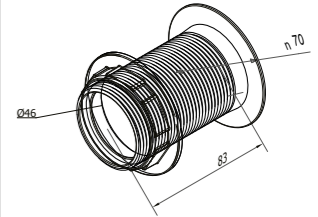

MMIO0085

M6 Blind Plug
M6 Kör Tapa

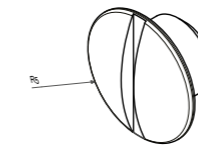

MMIO0086

M6 Mounting Screw
M6 Montaj Vidası

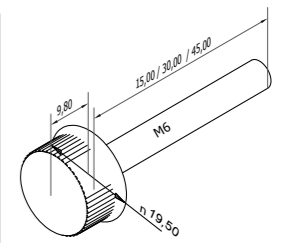

15mm - MMIO0023
30mm - MMIO0023
45mm - MMIO0023

Fan Circle Lock Plastic
Fan Çemberi Kilit Plastiği

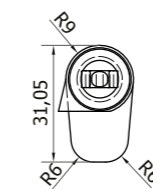

MMIO0046

Metal Inserted Plastics

Metal Bileşenli Plastikler

Frame Sheet Metal Inserted Cover Plastic Profile
Çerçeve Sac Bileşenli Kapak Plastik Profili

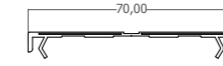
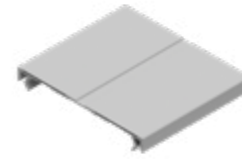

MME00035

Frame Sheet Metal Inserted Cover Plastic Profile
Çerçeve Sac Bileşenli Kapak Plastik Profili

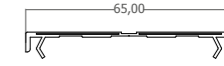
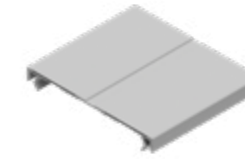

MME00035,5

Gravity Door Metal Inserted Hinge Plastic
Gravity Kapı Sac Bileşenli Menteşe Plastiği

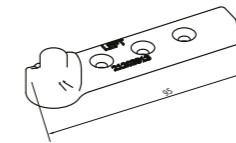

MMI00056

Door Top Pin Plastic with Metal Vending Inserted
Metal Otomat Bileşenli Cam Kapı Üst Pim Plastiği

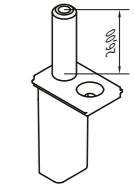

MMI00015

Door Pin Nut Inserted Adjustment Plastic
Kapı Pim Somunlu Ayar Plastiği

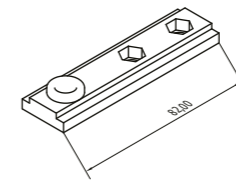

MMI00060

Gravity Frame Nut Inserted Hinge Plastic
Gravity Çerçeve Menteşe Somunlu Menteşe Plastiği

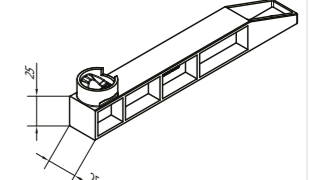
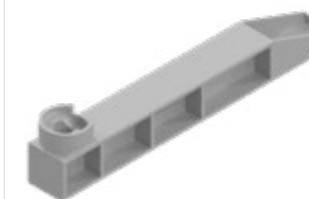

MMI00073

Door Pin Nut Inserted Adjustment Plastic 2
Kapı Pim Somunlu Ayar Plastiği

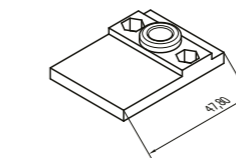

MMI00062

Bumper Profiles

Tampon Profilleri

"C" Shaped Bumper Profile + Mounting Bar
"C" Tampon Profili + Montaj Çıtası

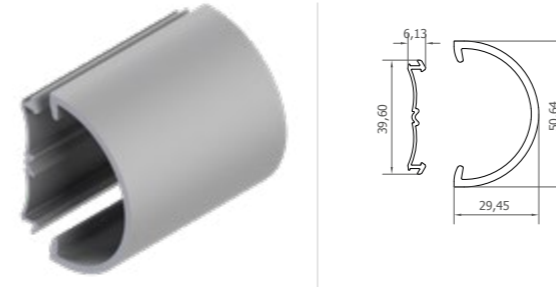

MME00148

"C" Shaped Bumper Profile End Plastic
"C" Tampon Profil Bitiş Plastiği

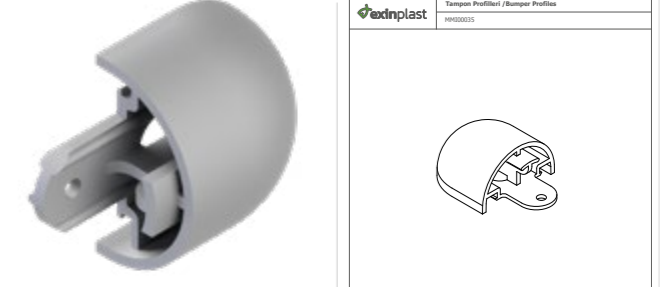

MMIO0087

"U" Bumper Profile + Mounting Bar
"U" Tampon Profili + Montaj Çıtası

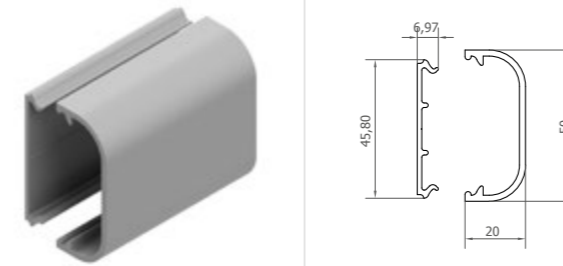

MME00055

"U" Shaped Bumper Profile End Plastic
"U" Tampon Profil Bitiş Plastiği

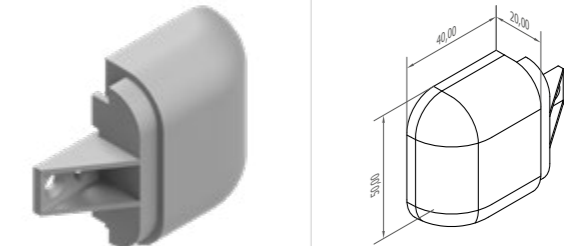

MMIO0006

"U" Shaped Bumper Profile Corner Plastic
"U" Bumper Profile Köşe Plastiği

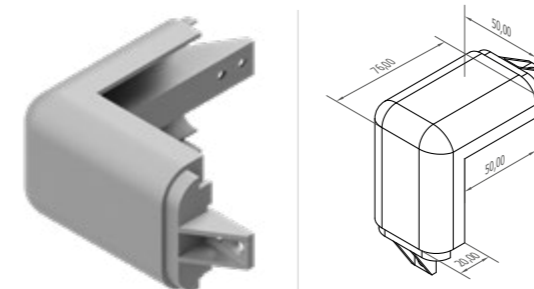

MMIO0008

"J" Shaped Bumper Profile + Mounting Bar
"J" Tampon Profili + Montaj Çıtası



MME00149

"D" Shape Bumper Profile + Mounting Bar
"D" Tampon Profili + Montaj Çıtası

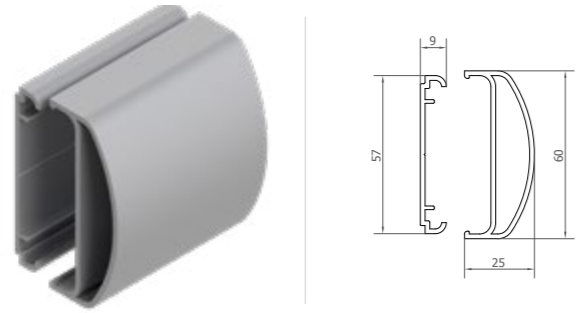

MME00084

"D" Shaped Bumper Profile End Plastic
"D" Tampon Profil Bitiş Plastiği

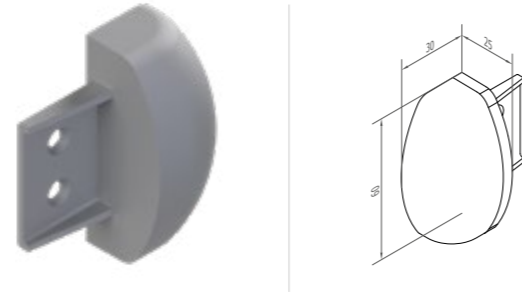

MMIO0066

"D" Shaped Bumper Profile Corner Plastic
"D" Bumper Profile Köşe Plastiği

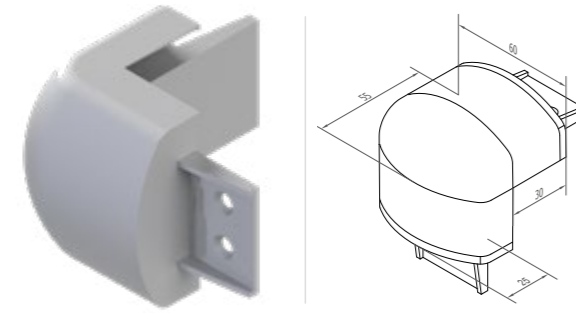

MMIO0089



Exinplast Plastik Profil Enjeksiyon Makine San. ve Tic. A.Ş.
Çeltikler Mah. Soğanlık Sk. No: 59 Geyve / Sakarya / Türkiye
T: +90 264 502 74 70 @: info@exinplast.com W: www.exinplast.com